

Description

General

The SFP-1000WB43-D20 transceiver from APC is small form factor pluggable module for serial optical data Communications applications specify of Gigabit Ethernet IEEE802.3z/D5 and Fiber Channel. This module is designed for single mode fiber with cost effective and high performance by using 1490 nm transmitter and 1310 nm receiver. It is with the SFP 20-pin connector to allow hot plug capability



Transmitter Section

The transmitter consists of a high-performance 1490 nm MQW DFB structure laser in the bi-directional optical subassembly (BOSA), which is housed within a metal package. In addition, this component is also class 1 laser compliant with according to International Safety Standard IEC-825

Receiver Section

The receiver contain of an integrated planar InGaAs PIN photodiode coupled to a high sensitivity transimpedance amplifier (TIA) in an BOSA. This BOSA combination is mated to a post amplifier IC that provides the post amplification and SD (Signal Detect) indication circuit, which provides LVTTTL logic low state output when an unusable input optical signal level is detected.

Features

- Single + 3.3 V power Supply
- Small Form Factor Pluggable MSA Compliant.
- PECL Differential Inputs and Output
- TTL Signal Detect Indicator.
- For Single Mode Applications
- LC Simplex Connector
- EEPROM with serial ID functionality.
- Class 1 Laser International Safety Standard IEC 825 Compliant
- Bi-directional Linking Distance Up to 20 km
- Temperature Ranges: 0 °C to +70 °C
- RoHS Compliant

Applications

- Bridges/Routers/intelligent hub and concentrators
- Gigabit Ethernet / Fiber Channel
- Storage Area Network

Performance Specifications

Absolute Maximum Ratings					
Parameter	Symbol	Min	Typ	Max	Unit
Supply Voltage	V _{CC}	0	-	5	V
Storage Temperature	T _S	-40	-	85	°C
Operating Temperature	T _{OP}	0	-	70	°C
Lead Soldering Limits	T _{SOLD}	-	-	260/10	°C/sec
General Specifications					
Parameter	Symbol	Min	Typ	Max	Units
Data Rate	B	-	1.25	-	Gbps
Supported Link Length on 9/125µm MMF	L	-	20	-	Km

Optical and Electrical Characteristics

Transmitter Electrical Characteristics					
Parameter	Symbol	Min	Typ	Max	Unit
Supply Voltage	V_{CC}	3.15	3.3	3.45	V
Supply Current	I_{CC}	-	-	160	mA
Data Differential Input Voltage	$V_{in, pp}$	300	-	1600	mV
Disable Input Voltage	$V_{IL} - V_{CC}$	-1.81	-	-1.48	V
Enable Input Voltage	$V_{IH} - V_{CC}$	-1.16	-	-0.88	V
Transmitter Optical Characteristics					
Parameter	Symbol	Min	Typ	Max	Unit
Output Optical Power	P_O	-8	-	-2	dBm
Center Wavelength	λ_C	1470	1490	1510	nm
Spectral Width (RMS)	$\Delta\lambda$	-	1	-	nm
Optical Rise Time (10%-90%)	t_r	-	-	0.26	ns
Optical Fall Time (10%-90%)	t_f	-	-	0.26	ns
Extinction Ratio	ER	8.2	-	-	dB

Receiver Electrical Characteristics					
Parameter	Symbol	Min	Typ	Max	Unit
Supply Voltage	V_{CC}	3.15	3.3	3.45	V
Supply Current	I_{CC}	-	-	100	mA
Data Differential Output Voltage	$V_{out, pp}$	300	-	1000	mV
Data Output Rise Time (10%-90%)	t_r	-	-	0.35	ns
Data Output Fall Time (10%-90%)	t_f	-	-	0.35	ns
Receiver Optical Characteristics					
Parameter	Symbol	Min	Typ	Max	Unit
Maximum Receiver Power	P_{in}	-3	-	-	dBm
Receiver Sensitivity	P_S	-	-23	-	dBm
Optical Center Wavelength	λ_C	1250	-	1350	nm
Signal Detect-Asserted	P_A	-	-	-23	dBm avg.
Signal Detect-Deasserted	P_D	-36	-	-	dBm avg.
Signal Detect-Hysteresis	$P_A - P_D$	0.5	-	-	dB

Ordering Information

SFP – 1000WB43 – D20

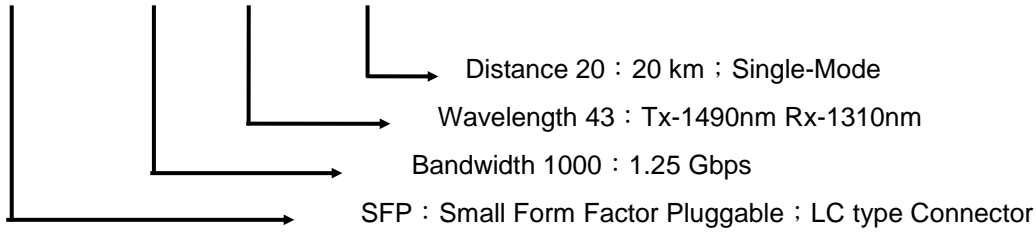

Recommended Circuit Schematic

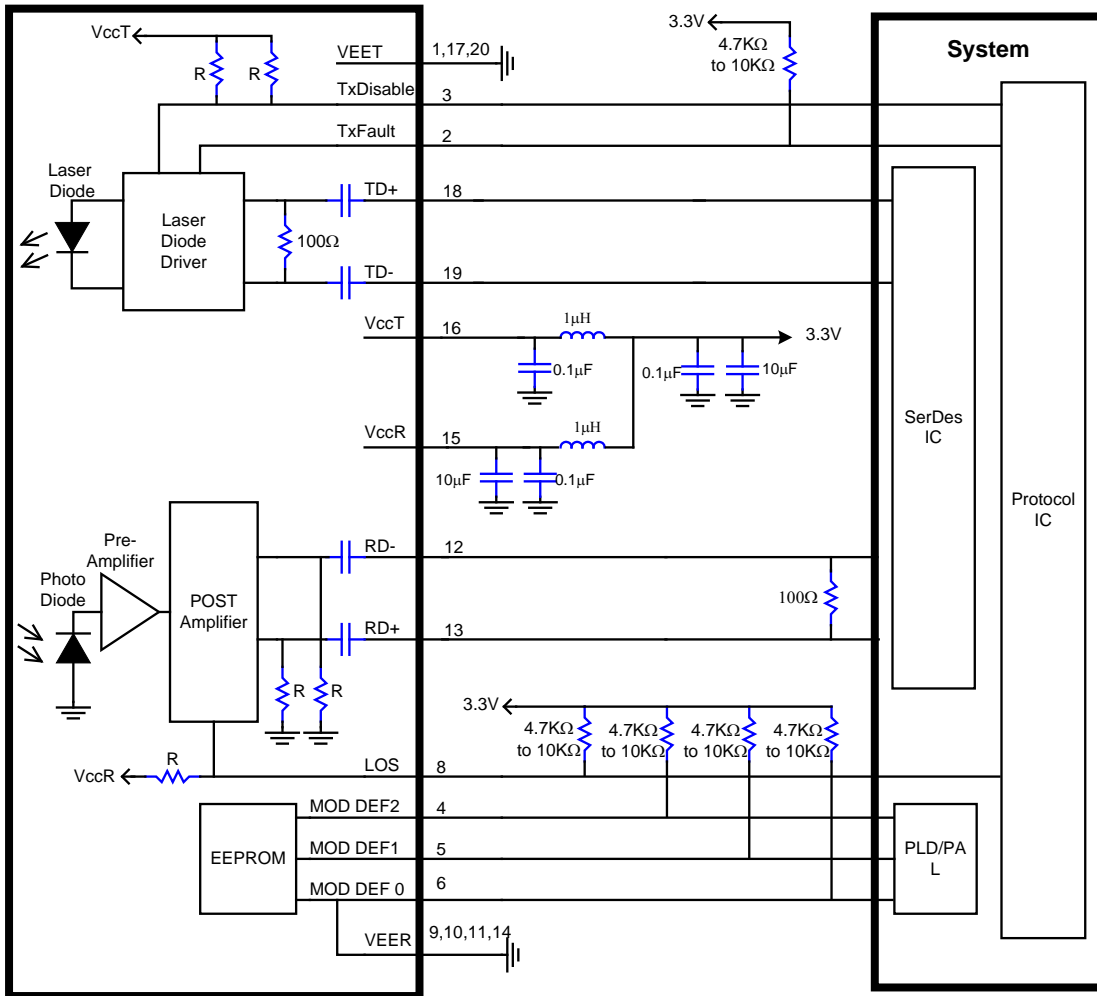

SFP Transceiver Electrical Pad Layout

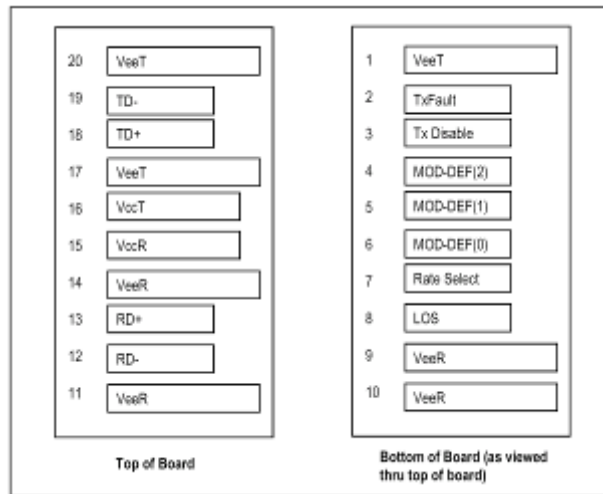

Pinout Table

Pin	Symbol	Name/Description	Ref.
1	V _{EET}	Transmitter Ground	1
2	T _{FAULT}	Transmitter Fault.	4
3	T _{DIS}	Transmitter Disable. Laser output disabled on high or open.	2
4	MOD_DEF (2)	Module Definition 2. Data line for Serial ID.	3
5	MOD_DEF (1)	Module Definition 1. Clock line for Serial ID.	3
6	MOD_DEF (0)	Module Definition 0. Grounded within the module.	3
7	Rate Select	No connection required	
8	LOS	Loss of Signal indication. Logic 0 indicates normal operation.	5
9	V _{EER}	Receiver Ground	1
10	V _{EER}	Receiver Ground	1
11	V _{EER}	Receiver Ground	1
12	RD-	Receiver Inverted DATA out. AC Coupled	
13	RD+	Receiver Non-inverted DATA out. AC Coupled	
14	V _{EER}	Receiver Ground	1
15	V _{CCR}	Receiver Power Supply	
16	V _{CCT}	Transmitter Power Supply	
17	V _{EET}	Transmitter Ground	1
18	TD+	Transmitter Non-Inverted DATA in. 100 ohm termination between TD+ and TD-, AC Coupled thereafter.	
19	TD-	Transmitter Inverted DATA in. See TD+	
20	V _{EET}	Transmitter Ground	1

Notes:

- Laser output disabled on TDIS >2.0V or open, enabled on TDIS <0.8V.
- Should be pulled up with 4.7k – 10kohms on host board to a voltage between 2.0V and 5.5V. MOD_DEF (0) pulls line low to indicate module is plugged in.
- TX-Fault is open collector output. Should be pulled up with 4.7k – 10k ohms on host board to a voltage between 2.0V and 5.5V.
- LOS is open collector output. Should be pulled up with 4.7k – 10k ohms on host board to a voltage between 2.0V and 5.5V. Logic 0 indicates normal operation; logic 1 indicates loss of signal.

Package Outline Drawing

Dimension (unit:mm)

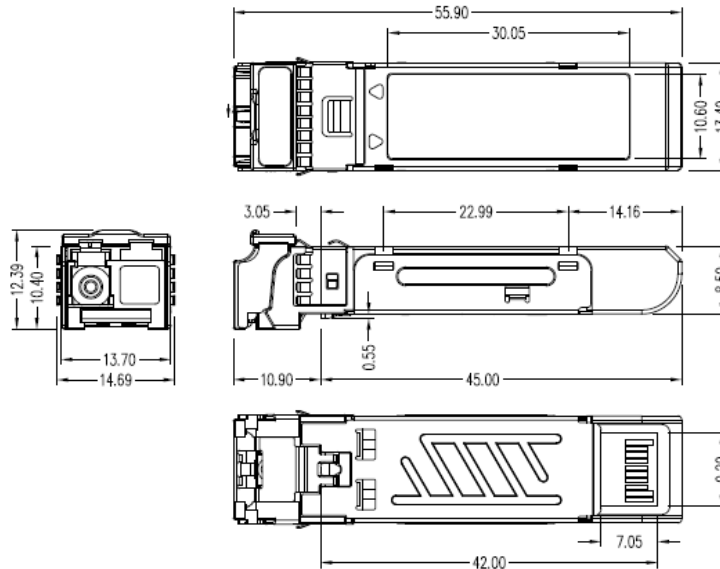

比例:2:1 公差:±0.2mm

RoHS Reference

Material Classify	Substance	Reference	Standard	Analysis	Equipment
Heavy Metals	Lead (Pb)/ Lead Compounds	2002/95/EC	< 1000 ppm	US EPA 3050B	ICP-AES
	Cadmium (Cd)/ Cadmium Compounds	2002/95/EC	< 100 ppm	EN1122-2001 91/338/EEC	ICP-AES
	Mercury (Hg) / Mercury Compounds	2002/95/EC	< 1000 ppm	US EPA 3052	ICP-AES
	Hexavalent-Chromium(Cr6+)Compounds	2002/95/EC	< 1000 ppm	US EPA 3060A & 7196A	UV-VIS
Brominated Organic Compounds	PolyBrominated Biphenyls (PBB)	2002/95/EC	< 1000 ppm	US EPA 3540 & 3550	GC/MS
	PolyBromo Diphenyl Ethers(PBDE)	2002/95/EC	< 1000 ppm	US EPA 3540 & 3550	GC/MS

Qualification Information

Heading	Test	Conditions	Sample Size	Reference
Mechanical & Physical	Mechanical Shock	5 times/axis 500G , 1.0ms	11	MIL-STD-883 Method 2002
	Vibration	20G , 20Hz - 2000HZ 4min/cycle ,4cycles/axis	11	MIL-STD-883 Method 2007
	Thermal Shock	Delta T=100°C	11	MIL-STD-883 Method 2003
	Solderability	-	11	MIL-STD-883 Method 2007
	Fiber Pull	1Kg ; 3times ; 5sec	11	Bellcore 983
Endurance	Accelerated Aging	85°C , 5000hrs	25	Bellcore 983 Section 5.18
	High Temperature Storage	85°C , 2000hrs	11	Bellcore 983
	Low Temperature Storage	-40°C , 2000hrs	11	Bellcore 983
	Temperature Cycling	500 cycles.	11	Bellcore 983 Section 5.20
	Cyclic Moisture Resistance	10 cycles	11	Bellcore 983 Section 5.23
	Damp Heat	40°C , 95% RH , 1344hrs	11	MIL-STD-202 Method 103
Special Test	Internal Moisture	<5000ppm water vapor	11	MIL-STD-883 Method 1018
	Flammability	-	-	TR357 Sec.4.4.2.5
	ESD Threshold	-	6	Bellcore 983 Section 5.22